

# Toggle IT

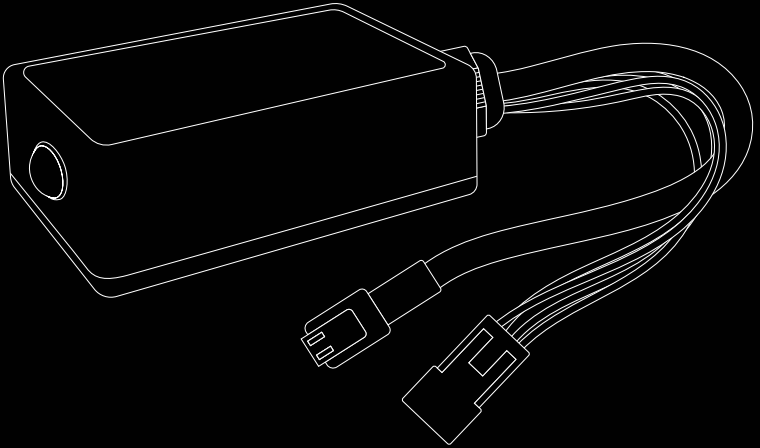



# ***SET IT AND FORGET IT***

***MAKING PROOF OF PLACEMENT EASY***

# Toggle IT







**USER MANUAL JULY 2022**

**PRODUCED BY**  **ONEIT**  
ELECTRONICS

# WARNINGS

**PLEASE READ AND UNDERSTAND THE INFORMATION IN THIS MANUAL BEFORE INSTALLING THIS UNIT.**

On2it Electronics is very safety conscious when designing and manufacturing consumer products, but it is essential that the product user also exercise care when using this device.

 <p>Do not use if any internal parts are damaged.</p>	 <p>Recycle product packaging as they are manufactured from recyclable materials.</p>
 <p>Do not immerse in water or other liquids.</p>	 <p>Handle with care as internal parts are fragile.</p>
 <p>Failure to connect unit correctly could result in damage to the unit or systems connected to it.</p>	 <p>We recommend installation is performed by an appropriately trained technician.</p>

*If you have any concerns regarding the performance or use of your device, please contact [admin@on2itelectronics.co.nz](mailto:admin@on2itelectronics.co.nz) or visit the On2it Electronics website for assistance.*

# DEVICE APPEARANCE

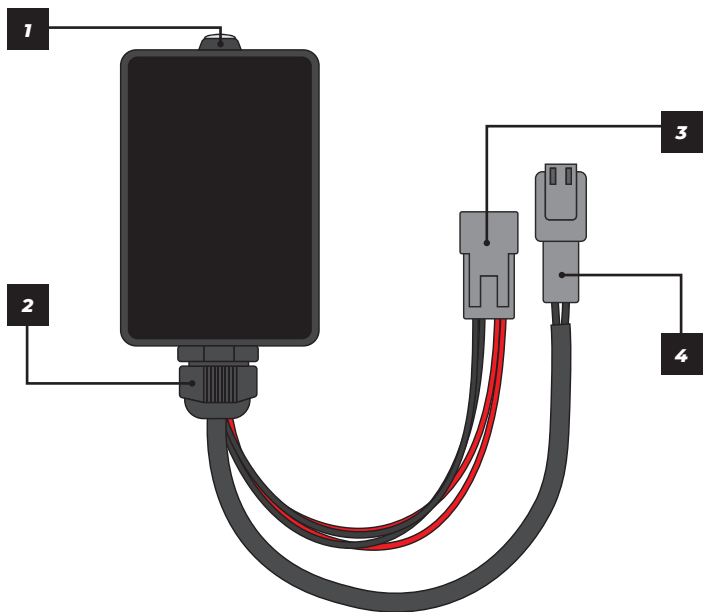

## TOGGLEIT UNIT

<b>1</b>	Button (red/green light)
<b>2</b>	Gland
<b>3</b>	4 pin plug - for adapter harness
<b>4</b>	2 pin plug - for GPS unit

# LIMITED WARRANTY

Thank you for your purchase. Upon purchasing this product you have agreed to the following warranty documentation.

On2it Electronics warrants that this product will

- i. Perform in the manner stated in the operating instructions and other documentation related to the product
- ii. That the product will be free from defects in materials and workmanship under normal use and service

**On2it Electronics warranties this product for the period of 12 months from the date of purchase.**

## NO OTHER WARRANTIES

TO THE MAXIMUM EXTENT PERMITTED BY APPLICABLE LAW, THE COMPANY AND ITS SUPPLIERS DISCLAIM ALL OTHER WARRANTIES, EITHER EXPRESS OR IMPLIED, INCLUDING, BUT NOT LIMITED TO IMPLIED WARRANTIES OF MERCHANTABILITY AND FITNESS FOR A PARTICULAR PURPOSE, WITH REGARD TO THE PRODUCT AND ANY RELATED WRITTEN MATERIALS. THIS LIMITED WARRANTY GIVES CUSTOMER SPECIFIC LEGAL RIGHTS.

## NO LIABILITY FOR DAMAGES

TO THE MAXIMUM EXTENT PERMITTED BY APPLICABLE LAW, IN NO EVENT SHALL ON2IT ELECTRONICS OR ITS SUPPLIERS BE LIABLE FOR ANY DAMAGES WHATSOEVER (INCLUDING WITHOUT LIMITATION, SPECIAL, INCIDENTAL, CONSEQUENTIAL, OR INDIRECT DAMAGES FOR PERSONAL INJURY LOSS OF BUSINESS PROFITS, BUSINESS INTERRUPTION, OR ANY OTHER PECUNIARY LOSS) ARISING OUT OF THE USE OF OR INABILITY TO USE THIS PRODUCT, EVEN IF ON2IT ELECTRONICS HAS BEEN ADVISED OF THE POSSIBILITY OF SUCH DAMAGES. IN ANY CASE, ON2IT ELECTRONICS AND ITS SUPPLIERS' ENTIRE LIABILITY UNDER ANY PROVISION OF THIS WARRANTY SHALL BE LIMITED TO THE AMOUNT PAID FOR THE PRODUCT BY THE CUSTOMER.

# **CUSTOMER REMEDIES**

On2It Electronics and its supplier's entire liability and customer's exclusive remedy shall be, at On2It Electronics option, either:

- i. Return of the price paid for the product
- ii. Repair or replacement of the product that does not meet this Limited Warranty and which is returned to On2It Electronics.

This limited warranty is void if failure of the product has resulted from accident, abuse, misapplication, water damage or incorrect installation of the product. Any replacement will be warranted for the remainder of the original warranty or 30 days, whichever is longer.

# **GENERAL RECOMMENDATIONS**

## **Before use:**

Remove cardboard protection pieces, protective film and adhesive labels from accessories.

Check the appliance for any transport damage.

## **During use:**

To avoid any damage do not place any weights on the appliance.

Do not expose the appliance to atmospheric agents

*Figures and illustrations in this User Manual are provided for reference only and may differ from actual product appearance. Product design and specifications may be changed without notice.*

## **INSTALLATION**

1. Locate your valve block.
2. Unplug one of the valves or the valve harness.
3. Install the adapter cable between the two plugs in the previous step.
4. Secure the adapter cable in position from the valve block to the ToggleIT location.
5. Connect the valve adapter harness to ToggleIT.
6. Connect the other cable to your GPS unit.
7. Start the machine – if this is ToggleIT's first run the button will flash red – go to setup step 2 if this happens. Otherwise, go to step 1 under setup instructions.
8. Configure your mapping software to suit ToggleITs output.

## **SETUP INSTRUCTIONS**

1. Hold down button until it flashes red.
2. Engage the hydraulic valve.
3. Press the button - button flashes green when valve has been found.
4. Disengage hydraulic valve.
5. Press button – button flashes green when setup is OK.
6. Once setup is complete when the valve is engaged the LED in the button will be green when it is disengaged the LED will be off.



# TROUBLESHOOTING

## *1. LED does not flash red on first start up:*

- i. Check all connections are secure and properly connected
- ii. The unit may have been setup already – follow setup steps

## *2. LED does not turn green when valve is engaged – unit may not be setup for the valve in use:*

- i. Follow the setup steps
- ii. Check that all the plugs and connections are secure and seated correctly

## *3. GPS unit is recording when valve is off:*

- i. Invert the spread switch setting on the GPS system

## *4. GPS unit is not recording at all:*

- i. Check the polarity of the GPS switch input the brown wire from ToggleIT is to be connected to the switch signal and the blue to ground. **FOR OTHER CONFIGURATIONS PLEASE CALL FOR ASSISTANCE.**

## *5. ToggleIT flashes red during setup – There was a problem during setup.*

- i. Run setup again
- ii. If unit fails again shut down machine – restart and run setup again
- iii. If the unit fails again contact us for assistance

## CONTACTS

Need help with your module or want a customised solution? We welcome feedback or any suggestions to improve our module. Contact our team on the details below or visit our website for more information.

 469B State Highway 10  
RD2, Kaikohe  
Northland 0472

 027 254 3914

 [admin@on2itelectronics.co.nz](mailto:admin@on2itelectronics.co.nz)

 [www.on2itelectronics.co.nz](http://www.on2itelectronics.co.nz)

Find us on Facebook @on2itelectronics 

***ToggleIT is a registered trademark. ToggleIT is proudly designed and manufactured in New Zealand by On2it Electronics Ltd.***

**©Copyright ToggleIT 2022**





**PRODUCED BY**  **ONEIT**  
ELECTRONICS